

Varenummer: 4320000651  
Beskrivelse: Rota-fix spændelement A 65x95  
Rustfast stål

## Mål

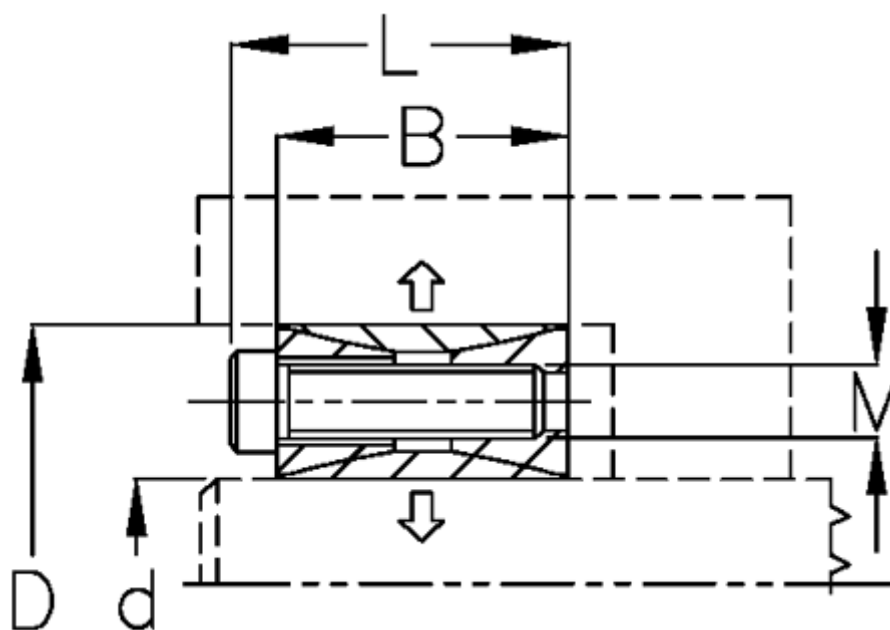

|  |                    |
|--|--------------------|
| B mm                                       | = 24               |
| d H8 mm                                    | = 65               |
| D mm                                       | = 95               |
| F kN aksialkraft                           | = 58.3             |
| L mm                                       | = 32               |
| M mm                                       | = M8               |
| Overfladeruhed                             | = R? ? 3.2 $\mu$ m |
| P N/mm <sup>2</sup> fladetryk på aksel/nav | = 49               |

|                               |                         |
|-------------------------------|-------------------------|
| T Nm drejningsmoment          | = 1800                  |
| Tolerance                     | = Aksel k11-h11, Nav M8 |
| Ts Nm boltetilspændingsmoment | = 21.4                  |